

PART NUMBER
13-547-344
NPI OR ECN NO.
ECO S-1686

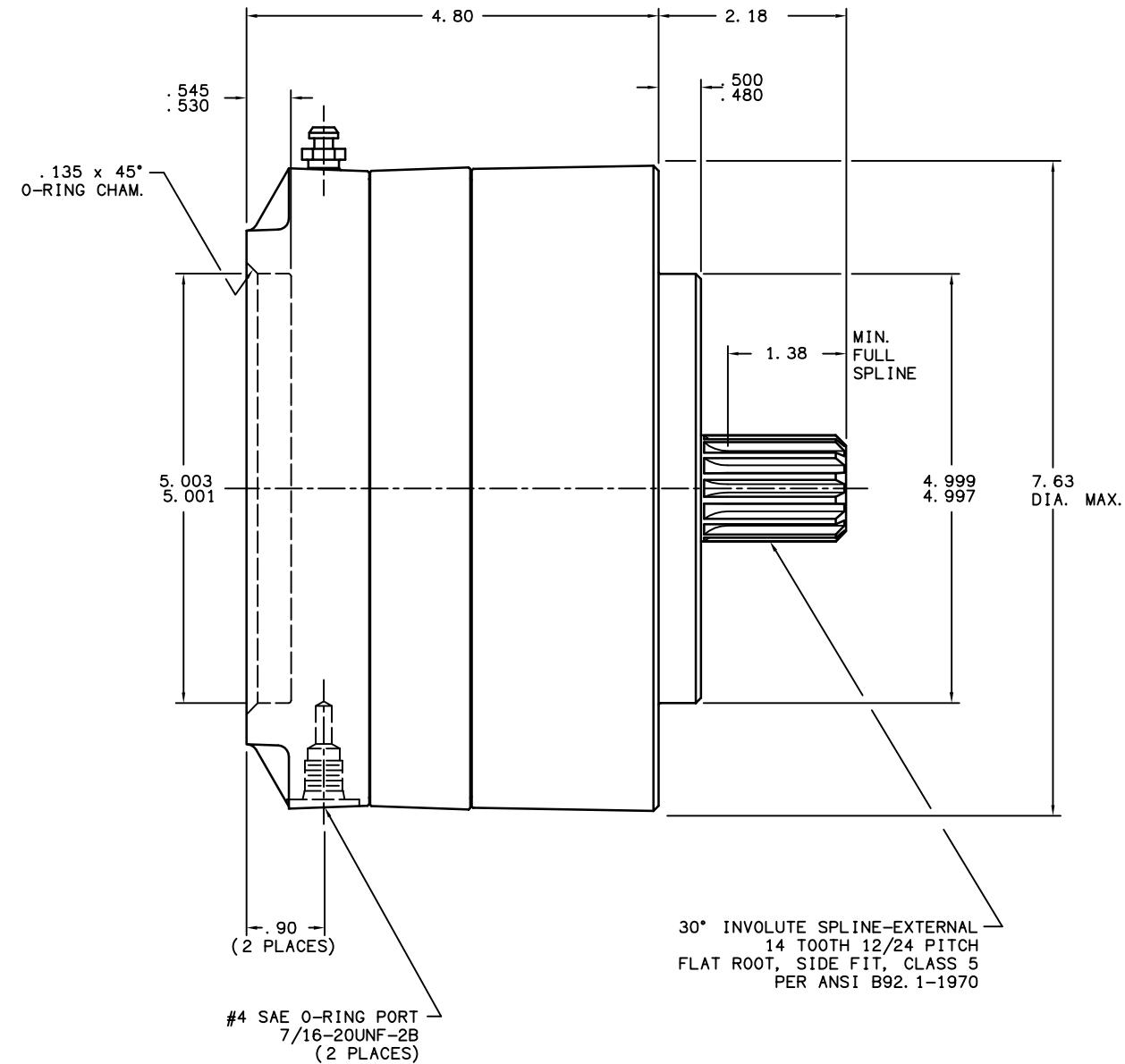
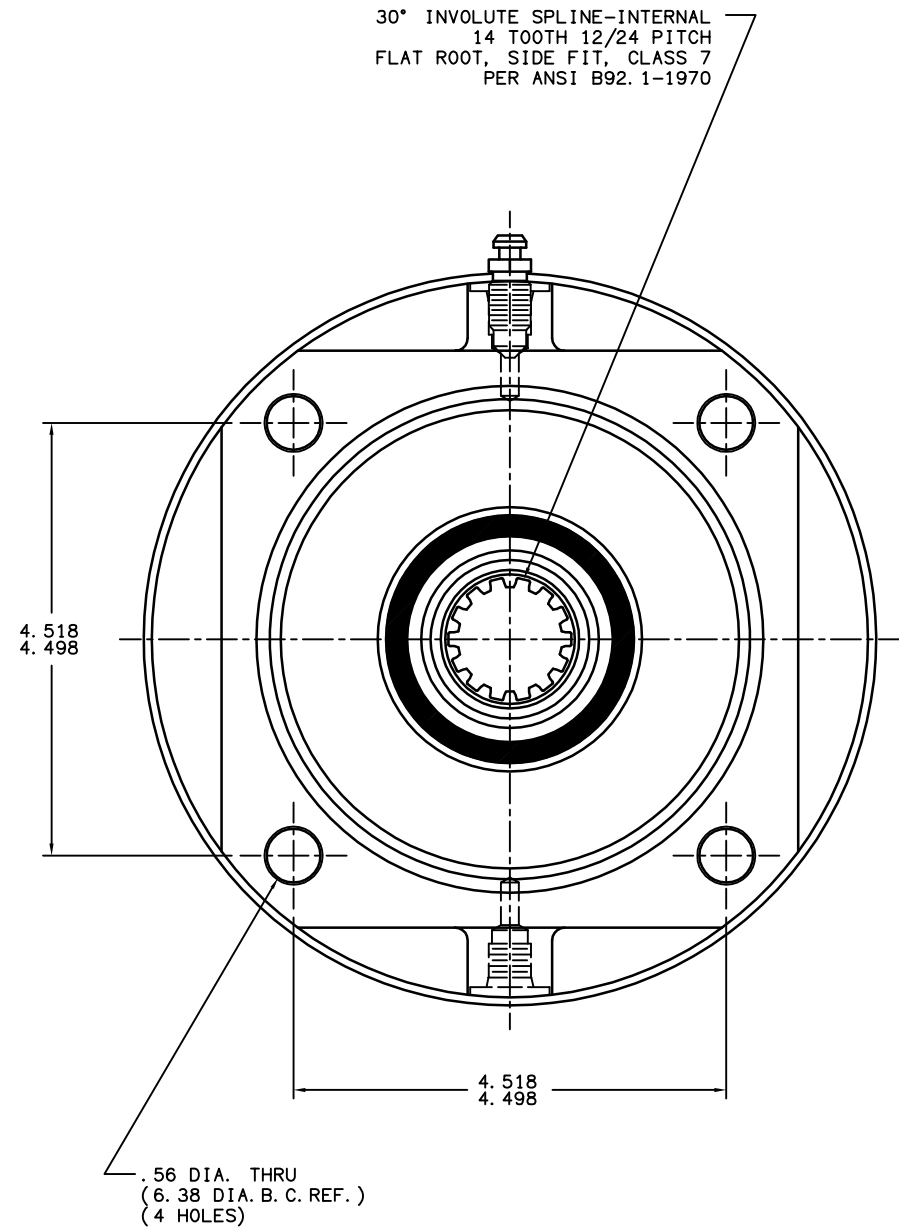

NOTES:

- 1.) LINING REPAIR KIT P/N 12-501-004
- 2.) BEARING REPAIR KIT P/N 12-501-182
- 3.) O-RING REPAIR KIT P/N 12-501-002
- 4.) SPRING REPAIR KIT P/N 12-501-008

SPECIFICATIONS:

TYPE: DRY MULTIPLE DISC BRAKE, SPRING APPLY, HYDRAULIC RELEASE

TORQUE RATING: 5,500 LB-IN STATIC (BREAKAWAY) AT 0 PSI BACK PRESSURE

RELEASE PRESSURE: 130 PSI INITIAL, 170 PSI FULL

MAXIMUM OPERATING PRESSURE: 3,000 PSI

MAXIMUM SPEED: 3,900 RPM

APPROXIMATE WEIGHT: 40 LBS.

FOR USE WITH MINERAL BASE HYDRAULIC OIL ONLY.



COMPONENT AND SYSTEM RECOMMENDATIONS MADE BY MICO, INC. ARE BASED ON INFORMATION SUPPLIED BY POTENTIAL USER AND/OR SYSTEM DESIGNER. THE POTENTIAL USER AND/OR DESIGNER MUST MAKE FINAL ACCEPTANCE AND APPROVAL OF COMPONENTS AND SYSTEM AFTER TESTING PERFORMANCE ON AN ACTUAL APPLICATION FOR WHICH SYSTEM WAS DESIGNED.

MICO, INC. CLAIMS PROPRIETARY RIGHTS TO THE MATERIAL DISCLOSED IN THIS DOCUMENT. THIS DOCUMENT IS PROVIDED IN CONFIDENCE AND MAY NOT BE REPRODUCED OR DISCLOSED WITHOUT WRITTEN PERMISSION FROM MICO, INC. COPYRIGHT MICO, INC. ALL RIGHTS RESERVED.

TITLE		MULTIPLE DISC BRAKE 3C-141455-CD	
SCALE 1:2	CHECKED G. J. 03/07/03	PART NUMBER 13-547-344	REV E
DRN G. J. 10/5/98	APP ENG GAA 03/06/03	CUSTOMER COPY	