

691 BRAKE LOCK SYSTEM



Operation and Installation Instructions

READ GENERAL INSTALLATION GUIDELINES SHEET (FORM NO. 81-600-001) BEFORE PROCEEDING.

WARNING

1. The ZF Off-Highway Solutions Minnesota Inc. 691 System is a **supplemental** safety device which provides additional brake holding action **when used with existing vehicle parking brake. It is not for dynamic service braking.**
2. The 691 System must be used in combination with an audible and/or visual alarm as a warning to signal the user of any loss of brake system pressure. **Do not disconnect warning devices.**
3. All lines, fittings, and surrounding areas must be cleaned of dirt or road residue before any lines or fittings are disconnected. Special care must be taken so dirt and road residue are not allowed to enter the hydraulic brake system. This can contaminate the system and interfere with proper operation of brakes and 691 Brake Lock System.
4. Follow procedures outlined in Vehicle Manufacturer Service Manual or SAE Standards when making new connections or adding to existing brake systems. Use only steel brake tubing conforming to SAE specifications.
5. **Vehicle Brake System:** Always use clean fluid conforming to vehicle manufacturer recommendations.
691 Power Unit: See *BEFORE PROCEEDING*, page 3 for proper fluid type. Contaminated or improper fluid may cause gummy deposits, softening and swelling of rubber seals, and may render the 691 System inoperative. Such a condition must be corrected immediately.
6. Do not use sealants, tapes, teflon or cement compounds on any connections or fittings. These sealants or compounds can contaminate the hydraulic brake system and interfere with the operation of brake components or 691 Brake Lock System.
7. All fittings and connections must be in good condition and properly torqued.
8. Brake hoses, brake lines, 691 Brake Lock System, brake components, cylinders, and all fittings must be routinely inspected for leaks, damage or wear. Proper fluid levels must be maintained. In the event of any loss of fluid, brake system must be carefully inspected for leaks.
9. When installation of 691 Brake Lock System is complete, 691 System and brake system must be bled of air. Bleed 691 System according to procedures outlined in this manual. Bleed brake system according to vehicle manufacturer recommendations.
10. If the gray wire comes into contact with a negative (-) battery connection or ground at any time, the vehicle brakes will apply. Refer to page 9. If the brown wire comes into contact with a positive (+) battery connection at any time, the vehicle brakes will apply. Refer to page 9.
11. The self-adhesive warning labels, on page 1, accompanying each brake locking device must be affixed in the vehicle cab in view of operator.
12. Keep this manual in the cab of the vehicle after installing the 691 System.

This publication is not subject to any update service. Information contained in this publication was in effect at the time the publication was approved for printing and is subject to change without notice or liability. ZF Off-Highway Solutions Minnesota Inc. reserves the right to revise the information presented or to discontinue the production of parts described at any time.



ZF Off-Highway Solutions Minnesota Inc.

1911 Lee Boulevard / North Mankato, MN U.S.A. 56003

Tel: +1 507 625 6426 **Fax:** +1 507 625 3212

Table of Contents

	Page
SELF ADHESIVE LABELS	1
INTRODUCTION	2
PRINCIPLE OF OPERATION	2
INSTALLING A 691 SYSTEM	3
IDENTIFY YOUR BRAKE SYSTEM	3-4
DIMENSIONAL DATA	5
MOUNTING	6
Actuator	6
Power Unit	6
Control Module	6
User Interface	6
PLUMBING	7
Single 691 Brake Lock System	7
Dual 691 Brake Lock System	7
3-Channel Anti-Lock 691 Brake Lock System	8
4-Channel Anti-Lock 691 Brake Lock System	8
WIRING	9
Wiring Instructions	9
Connecting External Inputs	9
Connecting the Vehicle Horn	9
Connecting Power for the Control Module	9
BLEEDING	10
Tips on Bleeding Brake Systems	10
Bleeding Procedures	10-11
HORN WARNING CIRCUIT TEST	11
691 OPERATING INSTRUCTIONS	11
Using 691 as a Lock System	11
Using 691 as an Interlock	12
691 System Installation Checklist(Insert)
BRAKE LOCK APPLICATIONS (Wiring Diagram)	14
INTERLOCK APPLICATIONS (Wiring Diagram)	15
TROUBLESHOOTING	16-18
691 MODEL NUMBERS AND REPLACEMENT PARTS	19-20
691 ACCESSORIES	19

SELF ADHESIVE LABELS

NOTE

All 691 models include the self adhesive labels shown below. Determine which labels are used in your application.

THIS NOTICE MUST BE AFFIXED ON DASH IN VIEW OF OPERATOR

⚠ WARNING	
<p>Serious injury or death can occur if these instructions are not followed</p>	
<p>This vehicle is equipped with 691 Brake Lock System.</p> <p>Operator must read and understand warnings and operating instructions before using vehicle (Form no. 81-690-032).</p> <p>Do not use 691 Brake Lock in place of original equipment parking brake.</p> <p>Always apply parking brake and other provided holding devices when using 691 System.</p> <p>Do not use 691 Brake Lock for overnight or prolonged parking.</p> <p>Release 691 Brake Lock before moving vehicle.</p> <p>691 Brake Lock and warning circuit are disabled if battery power is lost or disconnected.</p>	

Use in all applications.

THIS NOTICE MUST BE AFFIXED ON DASH IN VIEW OF OPERATOR

<p>Operator must read and understand Warnings and Operating Instructions before using vehicle (Form no. 81-690-032).</p> <p>691 Brake Lock</p> <p>TO LOCK:</p> <ol style="list-style-type: none">1. Set parking brake2. Move lock switch to LOCK position <p>TO RELEASE:</p> <ol style="list-style-type: none">1. Move lock switch to RELEASE position2. Release parking brake
--

Use in all applications using a user interface.

THIS NOTICE MUST BE AFFIXED ON DASH IN VIEW OF OPERATOR

⚠ WARNING
<p>Serious injury or death can occur if these instructions are not followed.</p> <p>Operator must read and understand warnings and operating instructions before using vehicle (Form no. 81-690-032).</p> <p>This vehicle is equipped with a 691 Brake Lock System that is activated by a remote input.</p> <p>Unintended operation of the remote input will cause the brakes to apply or release without warning.</p> <p>The operator must understand the function of the remote inputs.</p> <p>Be aware of all conditions that will cause the 691 Brake Lock System to activate or deactivate without user intervention.</p>

Use in all applications where the 691 System is remotely activated.

INTRODUCTION

Vehicles today have two separate brake systems. One is the service brake system and the other is the parking brake system. The service brake system is used to slow or stop a vehicle during normal operation. The parking brake system is usually cable operated and used to hold the vehicle stationary while parked.

Experience has shown that some vehicle applications require more brake holding capacity than provided by properly maintained parking brakes. The 691 Brake Lock System uses the vehicle service brakes to supplement the parking brake. The 691 System provides pressure to the service brake system in the same manner as when vehicle operator presses on the brake pedal.

The 691 also provides external inputs which can activate the system without direct operator interjection.

The 691 Brake Lock System consists of:

The Control Module and User Interface

(Figure 1)

The control module controls operation of the system through the user interface or remote activation. The user interface incorporates a manually activated switch, audible alarm, and "locked" lamp.

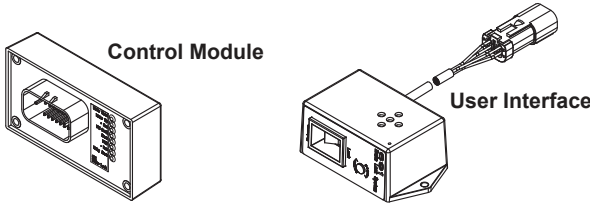

FIGURE 1

The Power Unit

(Figure 2)

The power unit uses a 12 volt DC pump to produce pressure in the vehicle service brake system to lock the brakes. The pump reverses flow to release locking pressure.

Two pressure switches are located on the power unit. The pressure switches sense the pressure that the power unit is producing. The high pressure switch starts and stops the pump while pressurizing the system. The low pressure switch starts and stops the pump while releasing pressure from the system. Although the power unit contains a built in fluid reservoir, a remote reservoir is available as an option for special applications. Refer to 691 Accessories chart on page 19.

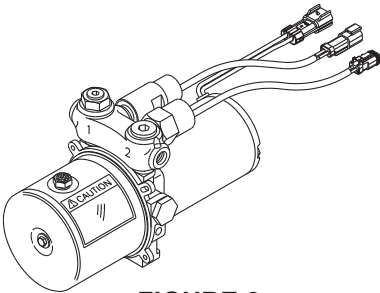

FIGURE 2

The Actuator

(Figure 3)

The actuator is a mechanical device that links the hydraulics of the 691 System to the vehicle service brake system. The actuator separates the 691 System fluid from the vehicle service brake system. Various actuators are available for use in different types of service brake systems.

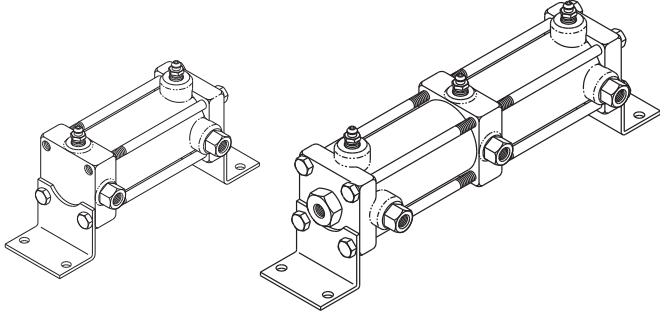

FIGURE 3

PRINCIPLE OF OPERATION

1. When the 691 System is activated, the control module starts the power unit pumping fluid into the actuator(s). As the actuator(s) become pressurized they isolate the vehicle master cylinder and pressurize the service brakes. When lock pressure is reached, the high-pressure switch signals the control module to stop the pump. While the pump is stopped, locking pressure is held in the brake system. If locking pressure drops, the high pressure switch signals for the power unit to turn "on" and restore locking pressure.
2. When the 691 System is deactivated, the pump reverses and releases pressure. The actuator releases pressure from the brakes and opens the ports to the vehicle master cylinder. When locked pressure returns to zero PSI a signal from the low-pressure switch stops the pump.

NOTE
Brake System fluid and 691 System fluid always remain isolated from one another.

INSTALLING A 691 SYSTEM

There are four steps to installing the 691 System.

1. Mounting
2. Plumbing
3. Wiring
4. Bleeding

The 691 System must only be installed by someone with good working knowledge of automotive brake and electrical systems.

It is important that the installer of the 691 System understands fluid types used in various 691 Systems. Read and understand this instruction manual before installing the 691 Brake Lock System.

Brake System Fluid

For all 691 installations the **vehicle's brake system fluid does not change**. Vehicles currently using brake fluid in the brake system will continue to use brake fluid. Vehicles currently using mineral base hydraulic oil in the brake system will continue to use mineral base hydraulic oil.

691 System Fluid

The 691 Power Unit design, assures seal compatibility with your existing brake system. **NOTE: Power unit and brake system fluids do not become intermixed when a 691 System is installed. The 691 Actuator(s) isolate the 691 System fluid from the brake system.**

BEFORE PROCEEDING:

1. Identify your vehicle brake system. See pages 3 & 4.
2. Be sure you have the correct 691 model number and it contains all the parts. Refer to Table 1 (pages 19 & 20).
All vehicles currently using automotive brake fluid (DOT 3, 4, 5 or 5.1) in the brake system must use the 691 model numbers designated (SF).
3. Check brake pedal height and feel. With the vehicle running, push on the brake pedal until there is no more forward movement. Measure and record the distance from pedal to floor. Brake pedal height and "feel" will be the same after the 691 System is installed, refer to Figure 4.

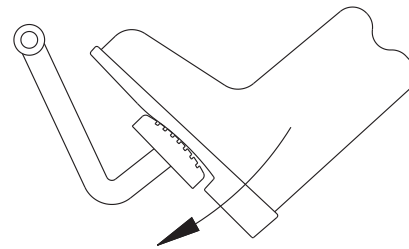

FIGURE 4

IDENTIFY YOUR BRAKE SYSTEM

Typical hydraulic braking systems in use today vary depending on manufacturer and size of vehicle. For instance, a vehicle equipped with a single system may have a firewall mounted booster or possibly a frame mounted remote booster. The same holds true for the dual and split systems. The rear wheel anti-lock system is a dual brake system with an anti-lock valve installed. All-wheel anti-lock systems are defined as 3-channel or 4-channel systems.

(Check the number of outlet lines from the anti-lock control valve). To be absolutely sure which braking system your vehicle is equipped with, check it. Look for identifying features such as dual flex lines at rear axle or front wheels, number of master cylinder lines, anti-lock valve(s), etc. Then, compare with the circuits shown in Figures 5 through 11.

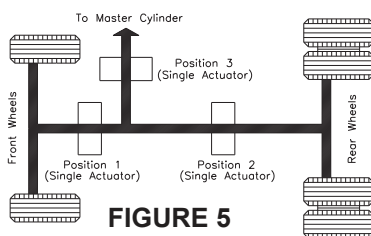

FIGURE 5

Typical Single System

One single hydraulic system serving both front and rear brakes.

Identifying Feature:

1. One line from master cylinder.

691 Actuator Position:

- (1) Front axle (2) Rear axle (3) 4-wheel

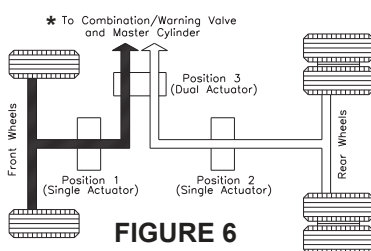

FIGURE 6

Typical Dual System (Vertical Split)

Two independent braking systems. One system leads to the front brakes and the other system to the rear brakes.

Identifying Feature:

1. Two lines from master cylinder.
2. Combination valve (used on some models).

691 Actuator Position:

- (1) Front axle (2) Rear axle* (3) 4-wheel

* Some imported vehicles use two separate air boosted master cylinders.

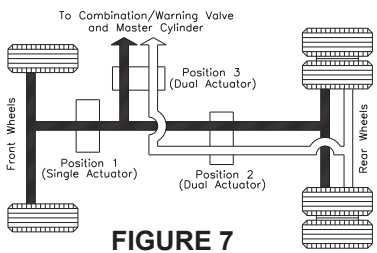

FIGURE 7

Typical Split System (1 1/2 x 1/2)

Two independent braking systems. One system leads to the front and the rear brakes and the other system leads only to the rear brakes.

Identifying Feature:

1. Two lines from master cylinder.
2. Single hose to each front wheel.
3. Two hoses to rear axle.

691 Actuator Position:

- (1) Front axle (2) Rear axle (3) 4-wheel

CAUTION: Whether position 2 or 3 is used, both halves of system must be locked.

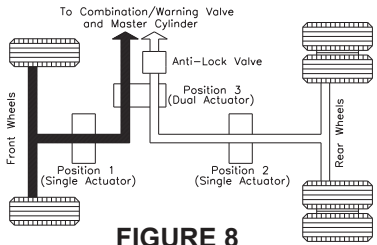

FIGURE 8

Typical Rear Wheel Anti-Lock System (Dual Vertical Split)

Two independent braking systems. One system leads to the front brakes and the other system to the rear brakes.

Identifying Feature:

1. Two lines from master cylinder.
2. Anti-lock control valve between master cylinder and rear wheels.

691 Actuator Position:

- (1) Front axle (2) Rear axle (3) 4-wheel

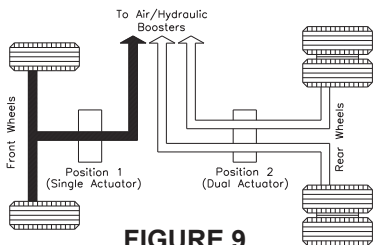

FIGURE 9

Imported Truck 3-Channel All-Wheel Anti-Lock System

Provides braking control by way of independent anti-lock channels for each rear wheel and a third channel for the front wheels.

Identifying Feature:

1. Three separate air/hydraulic brake boosters.
2. One line to front brakes.
3. Separate lines to each rear wheel.

691 Actuator Position:

- (1) Front axle (2) Rear axle (1 & 2) 4-wheel

NOTE: The anti-lock functions on air booster system, not the hydraulic side.

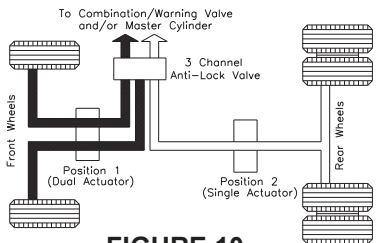

FIGURE 10

Typical 3-Channel All-Wheel Anti-Lock System

Provides braking control by way of independent anti-lock channels for each front wheel and a third channel for both rear wheels.

Identifying Feature:

1. Two lines from master cylinder to anti-lock valve(s).
2. One line from anti-lock valve to rear brakes.
3. Separate lines from anti-lock valve to each front wheel.

691 Actuator Position:

- (1) Front axle (2) Rear axle (1 & 2) 4-wheel

NOTE: Some 3-channel anti-lock brake systems use two separate anti-lock valves.

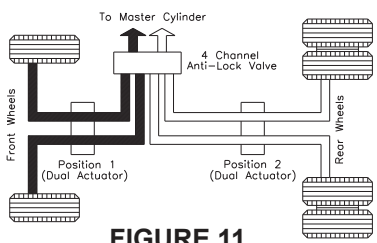

FIGURE 11

Typical 4-Channel All-Wheel Anti-Lock System

Provides braking control by way of an independent channel for each front wheel and each rear wheel.

Identifying Feature:

1. Two lines from master cylinder to anti-lock valve.
2. Separate lines from anti-lock valve to each of the front and rear wheels.

691 Actuator Position:

- (1) Front axle (2) Rear axle (1 & 2) 4-wheel

NOTE: Some 4-channel anti-lock brake systems use two separate anti-lock valves.

DIMENSIONAL DATA

1 1/4 inch Diameter Bore Dual Actuator

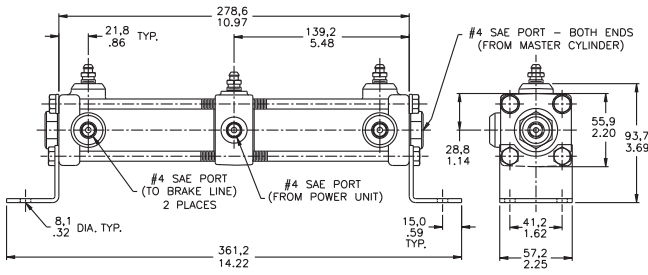

1 1/4 inch Diameter Bore Single Actuator

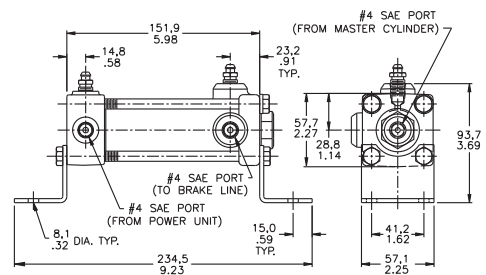

1 3/4 inch Diameter Bore Dual Actuator

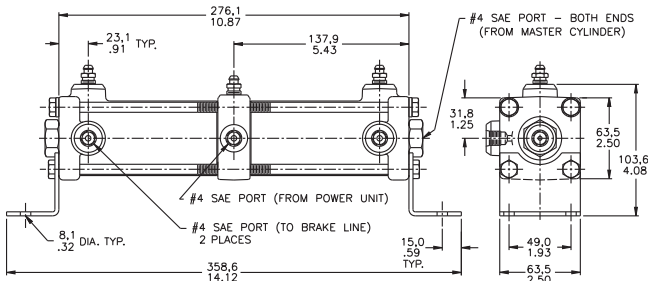

1 3/4 inch Diameter Bore Single Actuator

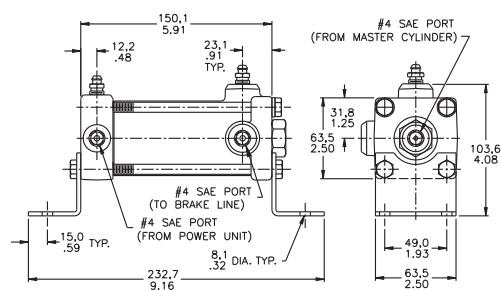

millimeters
inches

Power Unit

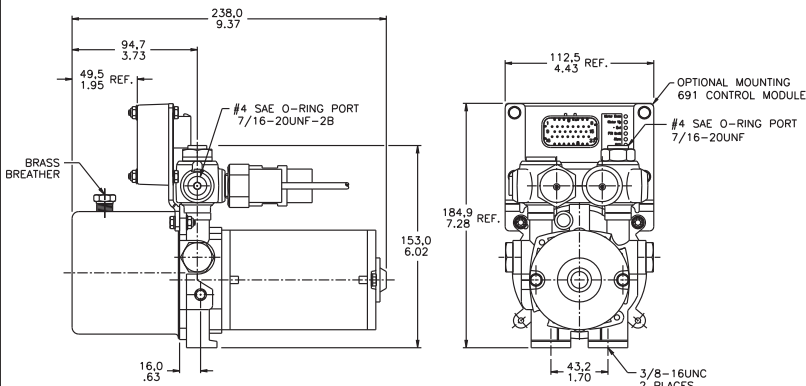

User Interface

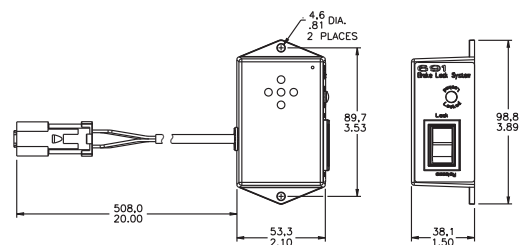

Control Module

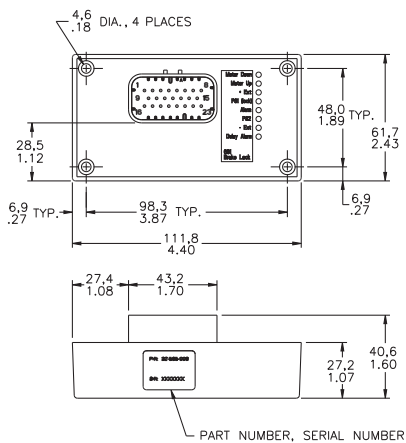

Remote Reservoir - (optional) See 691 Accessories on page 19

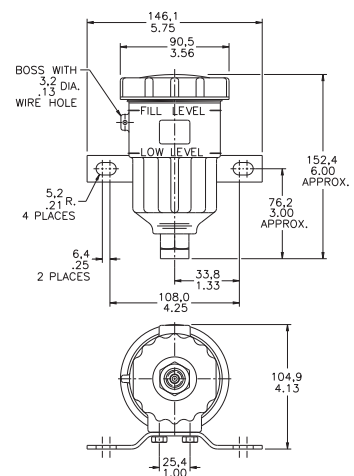

MOUNTING

Several self adhesive labels are supplied with each 691 Brake Lock. Determine which labels are used in your application and affix in the vehicle cab in view of the operator. See page 1.

Actuator

1. Repeat the mounting procedures for each actuator used in your system.
2. Find a location, preferably on the frame rail away from heat, where the actuator(s) will mount allowing easy access to brake lines, refer to Figure 12. The actuator(s) must be mounted horizontally below the level of the vehicle master cylinder. The bleeder screws must be in an upright position. Relocate the bleeder screws as necessary to maintain upright position. Torque bleeder screws 17.6-20.3 N·m (13-15 lb·ft).

FIGURE 12

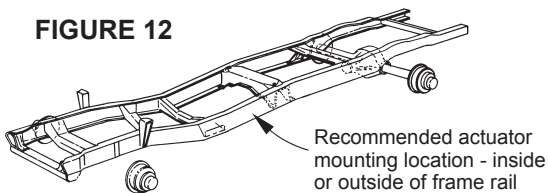

3. Using the actuator mounting brackets as a template, mark and drill four 11/32 inch diameter holes. Fabricated mounting brackets can be used to mount the actuator(s). The strength of fabricated brackets must be adequate to prevent flexing of brake lines.
4. Install the actuator using four 5/16-18UNC, grade 5, bolts, lock washers, and nuts. Torque 27.1-33.9 N·m (20-25 lb·ft).
5. Install the brass adapters from the fitting package in the actuator ports and torque 7.9-10.2 N·m (70-90 lb·in).

Power Unit

1. The power unit can be mounted horizontally in the engine compartment, on the frame rail, or in the cab. However, it must be protected from dirt, moisture, excessive heat, and possible impact. Do not mount the power unit in close proximity to heat sources such as exhaust or engine heat. Easy access to the reservoir breather/filler plug must be maintained to allow for filling and checking fluid level. The reservoir breather plug must be kept in an upright position. If this is not possible a remote reservoir can be installed, refer to 691 accessories on page 19.
2. Mark and drill two 7/16 inch diameter holes 2 5/16 inch apart. Fabricated mounting brackets can be used.
3. Mount the power unit using two 3/8-16UNC bolts and lock washers.
4. 691 models designated (SF) must use DOT 5 silicone fluid in the power unit reservoir. Check the CAUTION label around the power unit reservoir breather/filler plug to verify fluid type, refer to Figure 13.

FIGURE 13

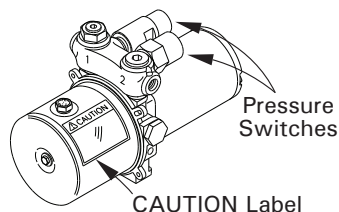

Control Module

1. A mounting bracket is provided with the 691 Control Module to mount the control module directly to the 691 Power Unit. See power unit dimensional drawing on page 5. The control module can be mounted on top of the power unit as shown, as well as mounted to either side. The control module can also be mounted to position the harness connection in the opposite direction shown.
2. When the 691 Control Module is not mounted to the 691 Power Unit, an optional 11 foot long wire harness (part number 32-820-022) is available. See page 19 for 691 Accessories. **Do not mount the control module in close proximity to heat sources such as exhaust or engine heat.**

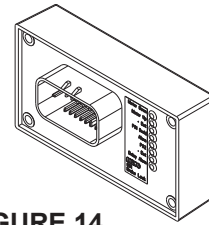

FIGURE 14

User Interface

1. The mounted user interface is provided for use by the operator in the cab. The user interface includes a manually activated switch, audible alarm, and "locked" lamp. Find a mounting location in the cab of the vehicle where:
 - A. The operator has easy access to the "lock" - "release" rocker switch.
 - B. The "lock" lamp is visible to the operator.
 - C. It is protected from having something spilled on it.
 - D. There is easy routing of wires from the 691 Control Module to the user interface.
2. The user interface is not necessary for applications where the 691 System is activated by other manual switches or electrical interlocks.

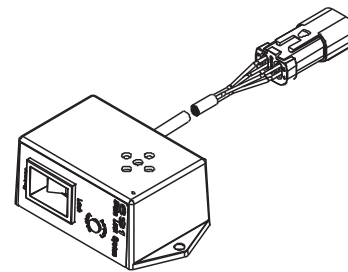

FIGURE 15

NOTE

When the 691 User Interface is not installed with this system, another visual identifier must be used to inform the operator that the 691 System is "locked". See schematic on page 14.

PLUMBING

Determine the type of brake system on your vehicle, refer to pages 3 and 4. All brake systems in use today require that the 691 Actuator(s) be installed **after** the anti-lock brake valve and combination warning valve if so equipped. Contact ZF Off-Highway Solutions Minnesota Inc. if you have questions.

Single 691 Brake Lock System

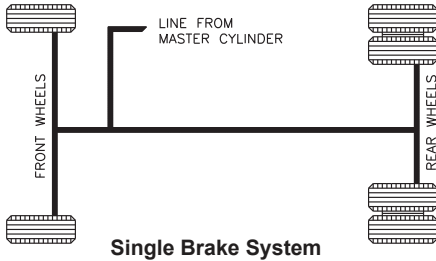

1. Disconnect the existing brake line necessary to install the single actuator. Reduce fluid loss by plugging the ports. Do not loosen or remove hydraulic lines that are not effected by the installation of the single actuator.
2. Determine the length and shape of new or modified brake lines needed to install the actuator. The installer must be qualified to modify existing brake tubing, or new factory double flared SAE approved brake line must be used. When adding or replacing brake lines, do not use smaller diameter than existing lines. The 691 Actuator is supplied with brass adapters designed to mate with 1/4 inch inverted flare tube nuts. Contact ZF Off-Highway Solutions Minnesota Inc. or a local brake fitting supplier to obtain proper fittings to install different size lines. All new connections or modifications between flexing vehicle sections, such as vehicle body and frame, must be made to absorb shock and vibration. Common methods used to absorb this shock are coiling the brake tubing or using a short length of purchased brake hose. Follow procedures outlined by the vehicle manufacturer or SAE specifications.
3. Connect the upstream line coming from the vehicle master cylinder to the fluid inlet port on the end of the single actuator. Connect the downstream line going to either the front or rear brakes from the side outlet port on the same end of the single actuator. See Figure 16.

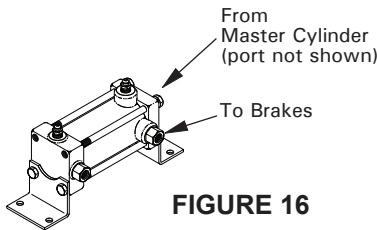

FIGURE 16

4. Determine the shape and length of a new piece of tubing to connect the power unit and single actuator. See Figure 17.

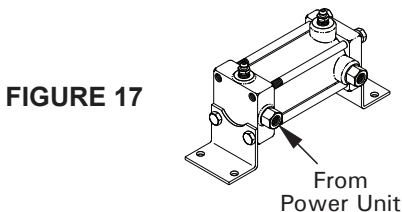

FIGURE 17

5. Connect one end of the new tubing to the single actuator.
6. Connect the other end of the new tubing to the power unit. This connection can be made to either the side or top port. Remove the plastic shipping plug from the top port. To install line in the side port use 3/16 inch hex key wrench to move the steel plug from side port to top port. Install the remaining brass adapter from the fitting package in the selected port prior to connecting the line. See Figure 18.

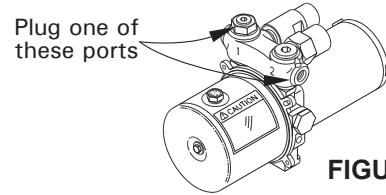
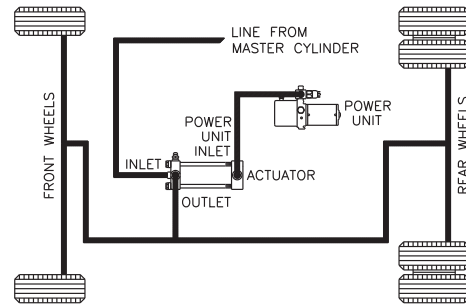
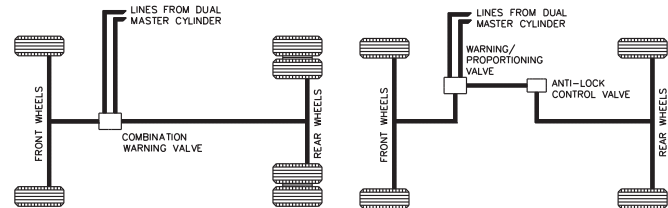

FIGURE 18



Single Brake System with 691 System

Dual 691 Brake Lock System



Dual Brake Systems

1. Disconnect the existing rear brake lines necessary to install the dual actuator. Reduce fluid loss by plugging the ports. Note which master cylinder port supplies fluid to the front brakes and rear brakes. Do not reverse the front and rear fluid paths during the installation of new brake lines.
2. Determine the length and shape of new or modified brake lines needed to install the dual actuator. The installer must be qualified to modify existing brake tubing, or new factory double flared SAE approved brake line must be used. When adding or replacing brake lines, do not use smaller diameter than existing lines. The 691 Actuator is supplied with brass adapters designed to mate with 1/4 inch inverted flare tube nuts. Contact ZF Off-Highway Solutions Minnesota Inc. or a local brake fitting supplier to obtain proper fittings to install different size lines. All new connections or modifications between flexing vehicle sections, such as vehicle body and frame, must be made to absorb shock and vibration. Common methods used to absorb this shock are coiling the brake tubing or using a short length of purchased brake hose. Follow procedures outlined by the vehicle manufacturer or SAE specifications.

3. Connect the upstream line coming from the master cylinder to the fluid inlet port on one end of the actuator. Note that the actuator is not directional and does not have a front and rear. Connect the downstream line going to the rear brakes from the side outlet port on the same end of the dual actuator. See Figure 19.

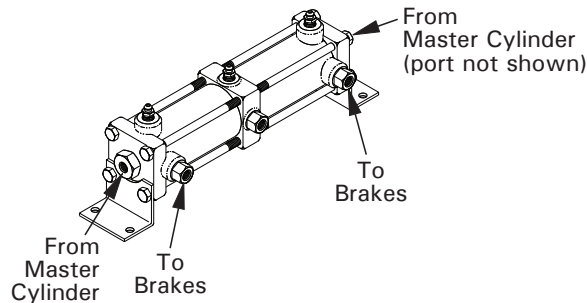

FIGURE 19

4. Repeat steps 1, 2, and 3 to install the front brake lines.
5. Determine the shape and length of a new piece of tubing to connect the power unit and dual actuator.
6. Connect one end of the new tubing to the dual actuator. See Figure 20.

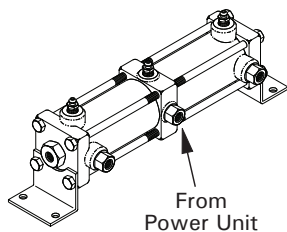

FIGURE 20

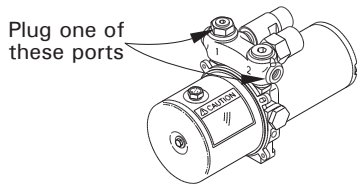
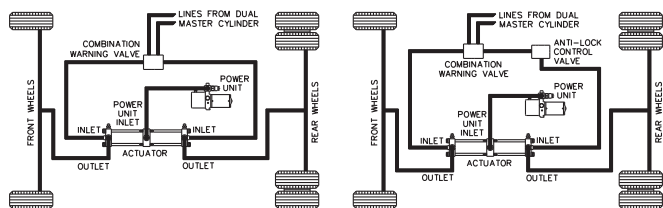

FIGURE 21

7. Connect the other end of the new tubing to the power unit. This connection can be made to either the side or top port. Remove the plastic shipping plug from the top port of the power unit. To install line in the side port use 3/16 inch hex key wrench to move the steel plug from side port to top port. Install the remaining brass adapter from the fitting package in the selected port prior to connecting the line. See Figure 21.



Dual Brake Systems with 691 System

3-Channel Anti-Lock 691 Brake Lock System

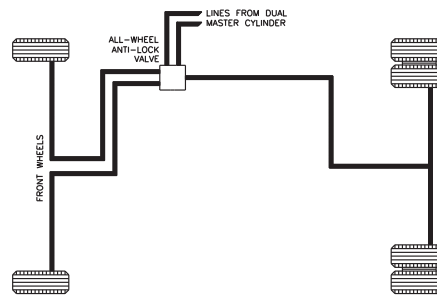

3 Channel Anti-lock Brake System

The 3-channel anti-lock brake system uses both a single and a dual actuator. Follow the plumbing instructions for both the Single 691 Brake Lock System and the Dual 691 Brake Lock System to connect the appropriate lines. To connect the hydraulic line from the power unit to both actuators, either a tee can be added to this line or the plug in the unused port on the pressure switch manifold can be removed to accommodate the connection.

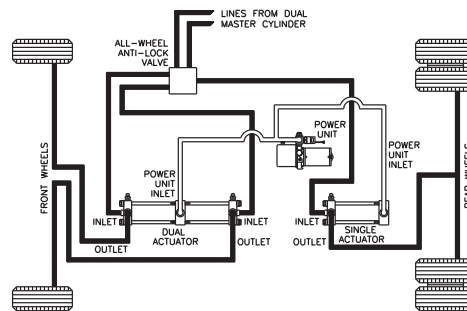

3 Channel Anti-lock Brake System with 691 System

4-Channel Anti-Lock 691 Brake Lock System

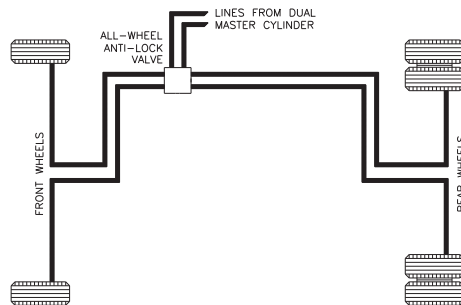

4 Channel Anti-lock Brake System

The 4-channel anti-lock brake system uses two dual actuators. Follow the plumbing instructions for the Dual 691 Brake Lock System to connect the appropriate lines. To connect the hydraulic line from the power unit to both actuators, either a tee can be added to this line or the plug in the unused port on the pressure switch manifold can be removed to accommodate the connection.

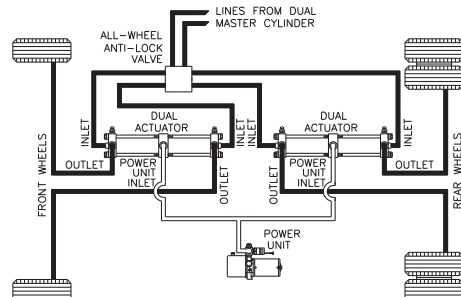

4 Channel Anti-lock Brake System with 691 System

WIRING

⚠ WARNING

Power is supplied to the 691 Control Module at all times. To prevent unintended actuation of the 691 System, be sure the “lock” - “release” switch (if applicable) is in the “release” position.

⚠ CAUTION

Do not operate the 691 Power Unit without first filling the power unit reservoir with proper fluid.

691 Wiring Instructions

(Refer to diagrams on pages 14 and 15)

The 691 System is designed for use on vehicles with a 12 volt DC, negative ground system. References to “ground” in this literature refer to vehicle chassis ground which is connected to the negative (-) battery terminal. References to “hot” or “positive” refer to connection to the positive (+) terminal of the 12 volt DC battery.

NOTE

All positive connections to the battery must be made through a high quality, properly rated fuse. Do not use a slow blow fuse or circuit breaker.

Optional extension harness (part number 32-820-022, page 19) is available when the control module is not mounted directly to the power unit. The supplied wire harness has been designed with sufficient wire length to complete most installations. If additional wire is necessary, be sure to use the proper gauge. When making wire connections, soldering and sealing with adhesive lined heat shrink is the recommended method. All wires that are not used must be sealed and insulated to keep from shorting to each other or ground.

Connecting External Inputs

Activating the 691 System by use of the user interface rocker switch is not always convenient. External inputs can activate the 691 System through the use of external switches, dash mounted switches or relays. This provides flexibility for manual operation by the user or allows other circuits to activate the brakes.

External Inputs

There are three external inputs available. The 691 is activated upon receiving a signal at **any** of the inputs and does not deactivate until all input signals have been removed.

Two of the external inputs are activated by a positive signal (+12 Vdc) and the third is activated by a negative (ground) signal.

The negative input is accessed from the gray wire in the main 691 Wire Harness.

The two positive inputs are:

1. The green wire in the user interface cable.
2. The brown wire in the main 691 Wire Harness.

NOTE: These inputs are connected together internally, so if one is receiving a positive signal, the other will also have a positive signal present. This is commonly used to provide an

external signal (to the brown wire) when the switch on the 691 User Interface is activated.

To prevent unintentional activation of the 691 System, insulate and seal any of the unused wires.

Using the Brown Wire as an External Output

When activating the 691 System with the user interface, the brown wire can be used to signal other circuits. It will provide a positive signal up to 1 amp of power to lights, relays, etc. If this current limit is exceeded, the output or control module may operate erratically or not at all.

NOTE: The brown wire will not provide an output when the 691 System is activated by the external input of the gray wire. This is an inherent design to provide protection from improper wiring.

⚠ WARNING

If the gray wire comes into contact with a negative (-) battery connection or ground at any time, the vehicle brakes will apply.

If the brown wire comes into contact with a positive (+) battery connection at any time, the vehicle brakes will apply.

Connecting the Vehicle Horn

The yellow 691 harness wire must be connected to a horn or other suitable warning device for your application. The yellow wire sends a ground signal to sound the horn when necessary.

1. On most vehicles the best way to connect this wire without adding a relay is to find the horn wire from the horn switch in the steering wheel. This switch typically grounds this wire to sound the horn, splicing in the yellow wire at this point is all that is necessary.
2. If splicing into the horn switch wire is not convenient, add a relay that is switched by the ground signal from the yellow wire and that connects the appropriate signal directly to the horn itself.

The yellow wire will provide a ground of up to 1 amp to drive a warning device. If this current limit is exceeded or if the yellow wire is connected improperly, the warning device or control module may operate erratically or not at all. Be sure to check for proper operation of the horn circuit on a regular basis. See page 11, “HORN WARNING CIRCUIT TEST”.

Connecting Power for the Control Module

1. Connect the black wire directly to battery negative or equivalent ground. This wire carries the full current of the 691 System and must have a good ground. If additional wire is necessary for this connection it must be a minimum of 14 gauge wire.
2. Connect the red wire to a 30 amp fuse which is connected directly to battery positive. This wire also carries full 691 System current. Do not connect this through any auxiliary wiring. Do not use a slow blow fuse or circuit breaker.

BLEEDING

⚠ CAUTION

Vehicle Brake System: Always use clean fluid conforming to vehicle manufacturer recommendations.

691 Power Unit: Check the CAUTION label on the 691 Power Unit reservoir for proper fluid type. Refer to Figure 13.

All electrical connections must be completed and the power unit reservoir filled with proper fluid before bleeding. The hydraulic brake system must be bled whenever any line has been disconnected. Although we recommend the use of pressure bleeding equipment when bleeding the system, some vehicle manufacturers do not advise certain bleeding methods. Refer to Vehicle Manufacturers bleeding recommendations. When pressure bleeding, use a system pressure of 1.72-2.07 bar (25-30 PSI).

Tips on Bleeding Brake Systems

1. Patience is often necessary. Brake fluids can be easily aerated by being forced through tubes too fast or agitating them. Once brake fluid has been aerated, the best way to get the air back out is to let it sit. Several hours or overnight may be necessary.
2. While bleeding, make every effort to move the fluid slowly. This is especially important when applying the brake pedal and when opening bleeder screws.
3. Avoid rapid pumping of the brake pedal as it can cause the fluid to become aerated.
4. Always wear safety glasses and be cautious when opening bleeder screws with any pressure applied. Air pockets will shoot the fluid out at a rapid rate.
5. Connect a length of poly-style air line from the bleeder screw into a container to recapture the fluid during the bleeding process.
6. In some cases, gravity bleeding is the best form of bleeding.
7. Start bleeding process at the actuators and work toward the foundation brakes.
8. Even when the brake system seems to be well bled, it may still contain small amounts of air. We recommend re-bleeding the brake system after the vehicle has been parked overnight.

Bleeding Procedures

NOTE

To assure successful brake system bleeding, complete all bleeding procedure steps in the order that they are listed.

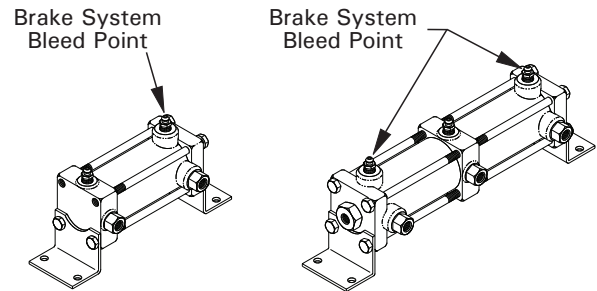

FIGURE 22

1. Disconnect the vehicle horn and other warning devices.
2. Be sure the 691 Power Unit reservoir remains filled with the proper fluid during entire bleeding process. Check the CAUTION label on the 691 Power Unit reservoir for proper fluid type.
3. Make sure the vehicle master cylinder reservoir is full of fluid specified by the vehicle manufacturer.
4. **Gravity Bleed** - After the initial installation, DO NOT apply the brake pedal. Remove the cap from the master cylinder reservoir. One at a time, open each bleeder screw in the vehicle brake system beginning with bleeder screws on the actuators and moving outward to the foundation brakes. **NOTE: In some situations, to save time, all bleeder screws may be opened simultaneously. Do not deplete reservoir fluid level.** When a steady stream of fluid is present, close the bleeder and proceed to the next. If gravity flow is not obtained within 5 minutes, proceed to next step. (Also check for blocked or crimped lines, or loops in tubing where air may be trapped).
5. **Manual Bleed** - Manually bleed the brakes, depressing and releasing brake pedal slowly and to disperse fluid through the brake system without agitating it. Do not depress pedal when bleeder screw is closed. Do not release pedal when bleeder screw is open. Bleed 691 Actuators first. After actuators are bled, continue by bleeding foundation brakes.
 - A. Open bleeder screw, then slowly apply the pedal to the limit of its stroke.
 - B. Close the bleeder and slowly release the pedal.
 - C. Repeat this process multiple times at each bleed point without pumping the pedal in-between.

6. **Pressure Bleed** - There are two options for pressure bleeding the brake system, either using a commercial pressurized bladder type bleeder or by activating the 691 Power Unit.

Using commercial bleeder:

Follow manufacturer's instructions.

Using 691 Power Unit:

- A. Activate the 691 System.

⚠ CAUTION

Be careful when opening the bleeder screw, it will be under high pressure. Wear safety glasses.

- B. Starting at the actuators and moving outward to foundation brakes, open bleeder screw 1/2 turn. The 691 Power Unit will run with the release of pressure and will stop automatically when the actuator reaches the end of its stroke. Most air will come out at end of the actuator stroke.
- C. After power unit stops running, close the bleeder screw.
- D. Deactivate the 691 System. After 691 Power Unit stops running, slowly depress and release brake pedal 3 to 5 times or until a firm pedal is achieved. This step is to replenish the actuators.
- NOTE: The 691 Power Unit will run during first brake application.**
- E. Be sure the 691 Power Unit reservoir and vehicle master cylinder reservoir remain filled with proper fluid.
- F. Repeat steps A through E at each bleed point until all air is purged before switching to the next bleed point.
- G. After the above steps are completed, check to see if brake pedal height and "feel" are the same as before the 691 System was installed. If the pedal does not "feel" as firm as before, let the vehicle sit for several hours or overnight and repeat pressure bleeding.
7. Activate the 691 System. Open bleeder screw 1/4 turn. See Figure 23. Close bleeder screw when a steady stream of fluid is present.

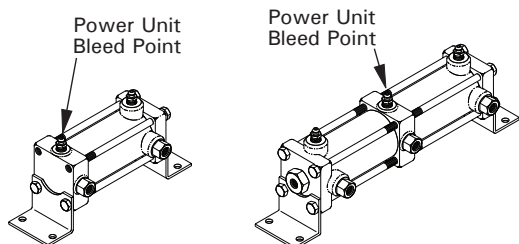

FIGURE 23

⚠ WARNING

Before moving the vehicle, a firm pedal must be achieved when the 691 System is deactivated. If a firm pedal is not achieved, repeat bleeding procedure for the 691 System and the service brake system until a firm pedal is achieved. Make several brake applications with the vehicle stationary and check fittings for leaks.

8. Reconnect horn or other warning devices.

HORN WARNING CIRCUIT TEST

The 691 Control Module provides two alarm wires: "direct alarm" and "delayed alarm". The "direct alarm" wire is the white wire in the 691 User Interface cable. It provides a ground signal whenever the system is pressurizing. It activates the 691 User Interface audible alarm. The "delayed alarm" wire, the yellow wire in the main 691 wire harness, is also referred to as the horn wire. It provides a ground signal if the system takes longer than nine seconds to initially pressurize, or anytime the system is re-pressurizing.

The yellow wire must be connected to the vehicle's horn or to a form of warning device that will guarantee that the operator is aware that the system is re-pressurizing. The horn warning circuit must be tested on a regular basis.

After the system has been activated and is locked, momentarily unplug the 2-wire (black & white) connector leading to pressure switch #1 (stamped "1-800"). While unplugged, the horn will activate. If the horn does not activate during this test, determine the cause of the problem and correct before using the 691 Brake Lock System.

691 OPERATING INSTRUCTIONS

⚠ CAUTION

Do not operate 691 Power Unit without first filling with proper fluid.

Using 691 as a Lock System

(Only units with 691 User Interface)

To Activate Lock System

1. Bring vehicle to a complete stop.
2. Set mechanical parking brake.
3. Move the user interface lock/release switch to the "lock" position.
4. User Interface alarm will sound and then deactivate after reaching locking pressure.
5. The "locked" indicator lamp will come on after locking pressure is reached.
6. Apply other provided holding devices.

NOTE

If pressure drops below required system pressure, the "locked" indicator lamp will go off and user interface alarm will activate. This process may take only a fraction of a second.

⚠ CAUTION

If user interface alarm does not sound or fails to deactivate or if the "locked" indicator lamp does not remain on, discontinue use of the 691 Brake Lock System. Determine the cause of the problem and correct before using.

To Deactivate Lock System

1. Disengage other provided holding devices.
2. Switch the user interface to "release" position. The "locked" indicator lamp will deactivate and the 691 Power Unit will return brake system to static system pressure.
3. Release mechanical parking brake.

Using 691 as an Interlock

NOTE

The 691 Interlock can be activated by the rocker switch (if applicable) whether the vehicle's ignition is on or off as long as the battery connection exists.

To Activate

1. Bring vehicle to a complete stop.
2. Set mechanical parking brake.
3. Satisfy the conditions that activate remote input.

To Deactivate

1. Disengage other provided holding devices.
2. Deactivate remote input.
3. Release mechanical holding devices.

NOTE

To release the brakes in case of an electrical failure complete the following steps:

- A. Remove 691 System fuse.
- B. Apply other provided holding devices and mechanical parking brake to keep the vehicle from rolling.
- C. Release residual pressure from 691 System by carefully loosening bleeder screw nearest the power unit inlet port of 691 Actuator. Be careful when opening the bleeder screw, it may be under high pressure.
- D. Disengage other provided holding devices.
- E. Release mechanical parking brake.

NOTES

691 System Installation Checklist

NOTE: As you install the 691 System complete this check list. Upon completion of the 691 installation, retain this checklist with the 691 Operation and Installation Manual.

Date installed: _____ Name of person(s) installing: _____

Vehicle make: _____ Model: _____ Year: _____

Vehicle I.D. number: _____

Model number of 691 System installed: _____

Complete this section after Mounting the 691 System

<input type="checkbox"/> Yes	<input type="checkbox"/> No	1. Is the 691 Power Unit mounted upright and level?
<input type="checkbox"/> Yes	<input type="checkbox"/> No	2. Is the power unit breather plug clean and away from contaminants?
<input type="checkbox"/> Yes	<input type="checkbox"/> No	3. Can the fluid in the power unit reservoir be easily checked?
<input type="checkbox"/> Yes	<input type="checkbox"/> No	4. Is the actuator(s) mounted at a lower level than the vehicle master cylinder?
<input type="checkbox"/> Yes	<input type="checkbox"/> No	5. Is the actuator mounted horizontally level with bleeder screws facing up?
<input type="checkbox"/> Yes <input type="checkbox"/> N/A	<input type="checkbox"/> No	6. Is the user interface (if used) mounted where it can be easily seen and away from where it will get spilled on?

If you have checked "no" in any of the above boxes, determine the reason and correct.

Complete this section after Plumbing the 691 System

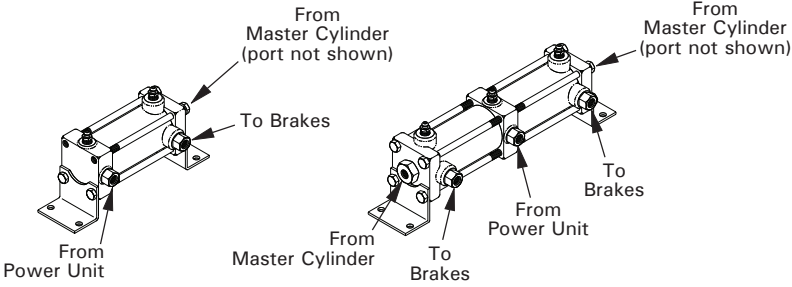
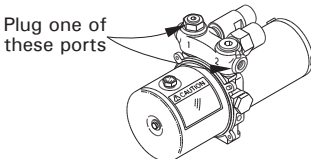
<input type="checkbox"/> Yes	<input type="checkbox"/> No	<p>1. Are all fluid lines properly connected as shown?</p> 
<input type="checkbox"/> Yes	<input type="checkbox"/> No	<p>2. Is the unused port on the power unit pump manifold properly plugged?</p> 
<input type="checkbox"/> Yes	<input type="checkbox"/> No	3. Have all upward "U" shapes in the fluid lines where air can be trapped been eliminated?
<input type="checkbox"/> Yes	<input type="checkbox"/> No	4. Have fluid line connections between flexing vehicle sections been made using coiled tube or brake hose that will absorb shock?
<input type="checkbox"/> Yes	<input type="checkbox"/> No	5. Is there a proper fluid level of clean appropriate fluid in the power unit reservoir or remote reservoir?
<input type="checkbox"/> Yes	<input type="checkbox"/> No	6. If an optional remote reservoir is used, was the power unit reservoir topped off first?
<input type="checkbox"/> Yes	<input type="checkbox"/> No	7. Is the vehicle master cylinder reservoir at the full level with proper fluid?

If you have checked "no" in any of the above boxes, determine the reason and correct.



Complete this section after Wiring the 691 System

<input type="checkbox"/> Yes <input type="checkbox"/> No	1. Are the wires protected from being hit or kicked and not hanging loose or pulled too tight?
<input type="checkbox"/> Yes <input type="checkbox"/> No <input type="checkbox"/> N/A	2. If additional wire was added, is it the correct gauge and color as indicated in the 691 Operation and Installation Manual?
<input type="checkbox"/> Yes <input type="checkbox"/> No	3. Trace each wire, are all wires either connected to something or properly capped off?
<input type="checkbox"/> Yes <input type="checkbox"/> No	4. Did the horn sound during the HORN WARNING CIRCUIT TEST as indicated in the 691 Operation and Installation Manual?
<input type="checkbox"/> Yes <input type="checkbox"/> No <input type="checkbox"/> N/A	5. If the gray wire is connected to an input, does it work properly?
<input type="checkbox"/> Yes <input type="checkbox"/> No <input type="checkbox"/> N/A	6. If the brown wire is connected to an input, does it work properly?
<input type="checkbox"/> Yes <input type="checkbox"/> No <input type="checkbox"/> N/A	7. If the brown wire is connected to an output, does it work properly?
<input type="checkbox"/> Yes <input type="checkbox"/> No <input type="checkbox"/> N/A	8. If the brown wire is connected to both an input and output, do they work properly?
<input type="checkbox"/> Yes <input type="checkbox"/> No	9. Is the red wire connected directly to positive battery through a 30 amp fuse and not a circuit breaker?

If you have checked “no” in any of the above boxes that apply to your application, determine the reason and correct.

Complete this section after Installing the 691 System

<input type="checkbox"/> Yes <input type="checkbox"/> No	1. Have the warning labels been installed in the vehicle cab in view of the operator?
<input type="checkbox"/> Yes <input type="checkbox"/> No	2. Activate the 691 System. Does the power unit run for approximately 4 seconds?
<input type="checkbox"/> Yes <input type="checkbox"/> No	3. Deactivate the 691 System. Does the power unit run for approximately 6 seconds?
<input type="checkbox"/> Yes <input type="checkbox"/> No	4. Remove the cover from the vehicle master cylinder reservoir and activate the 691 System. There may be an initial swirl but the fluid level will remain the same unless the system has been improperly plumbed. Is the fluid level remaining the same?
<input type="checkbox"/> Yes <input type="checkbox"/> No	5. Is the 691 Operation and Installation Manual stored in the cab of the vehicle?

If you have checked “no” in any of the above boxes, determine the reason and correct.

BRAKE LOCK APPLICATIONS

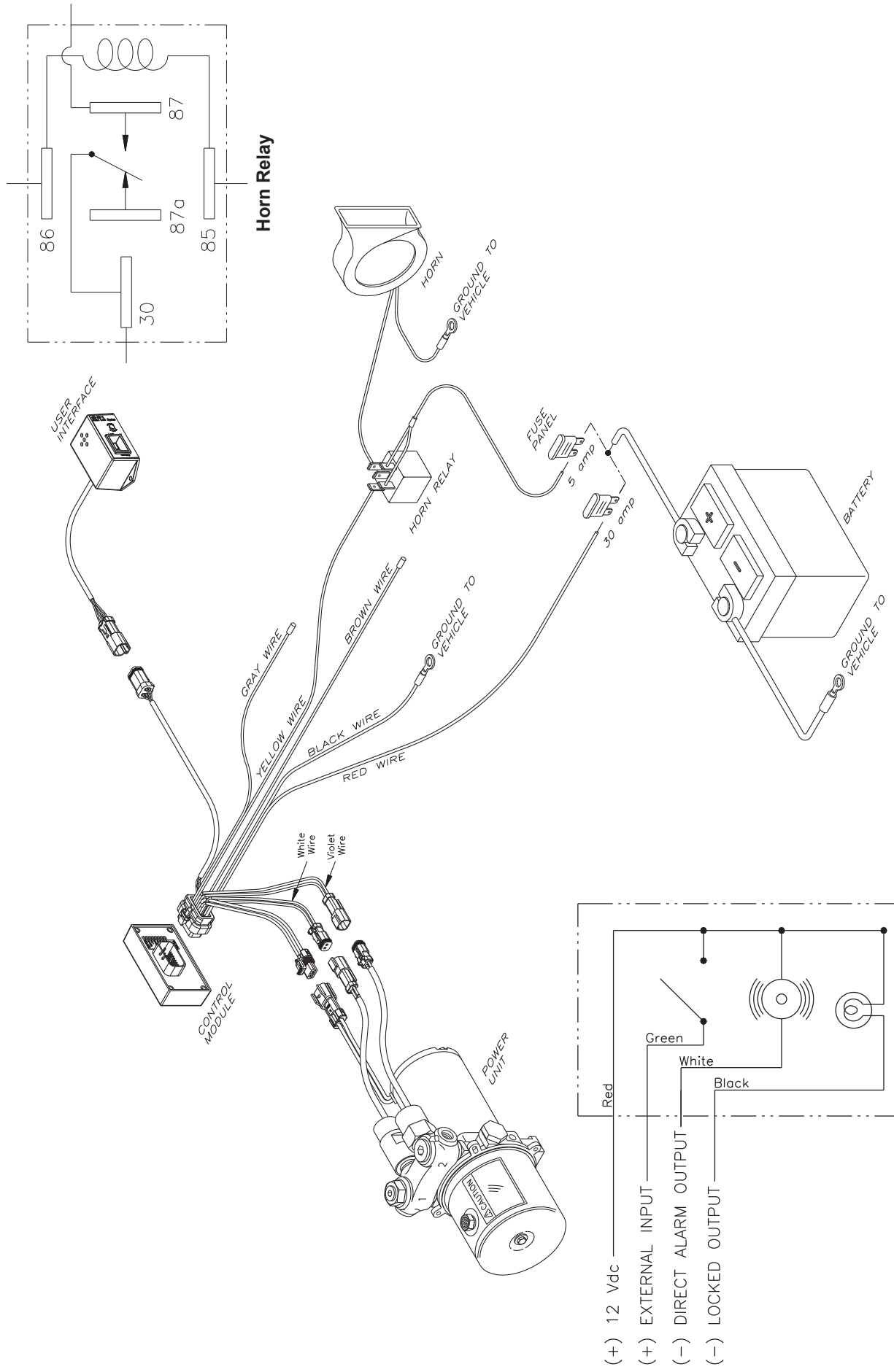

INTERLOCK APPLICATIONS

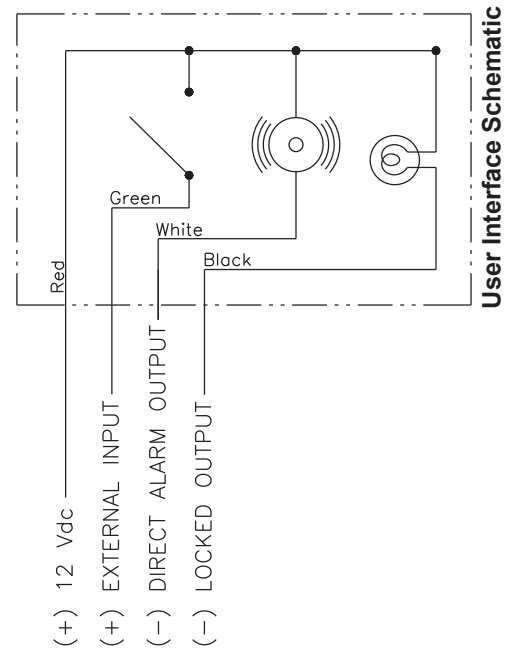
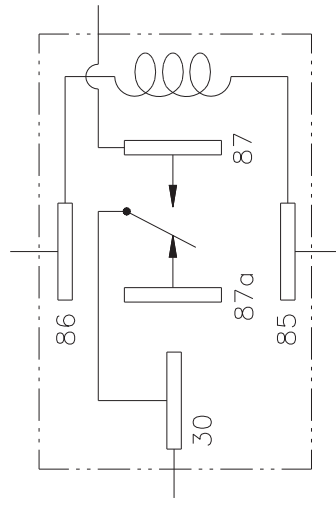
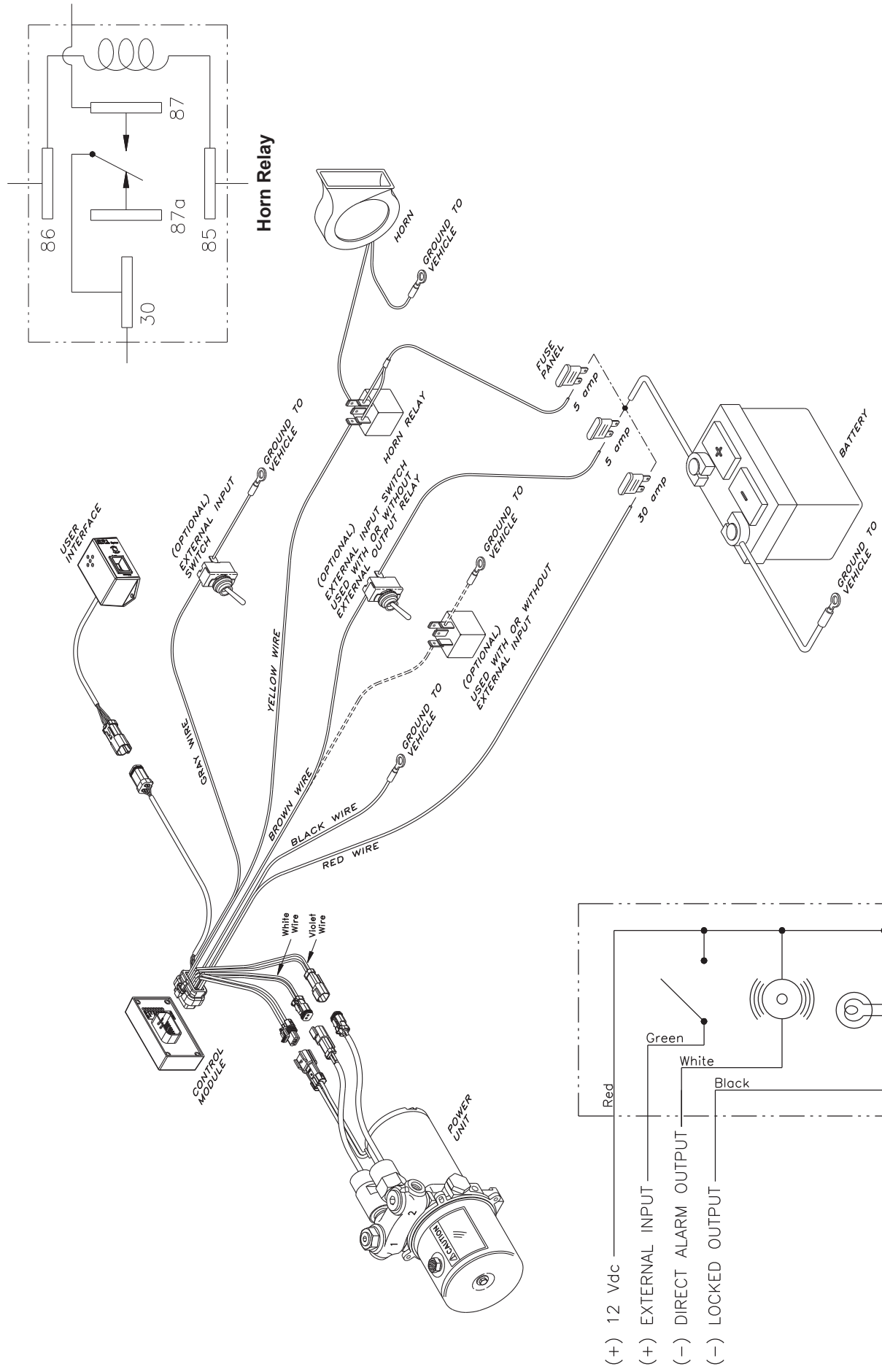

Before Troubleshooting

Unplug wire harness connectors. Check to be sure contacts are clean and making good contact and reconnect. Check the integrity of all wiring at the connectors. Also check to be sure all unused wires are properly capped.

TROUBLESHOOTING

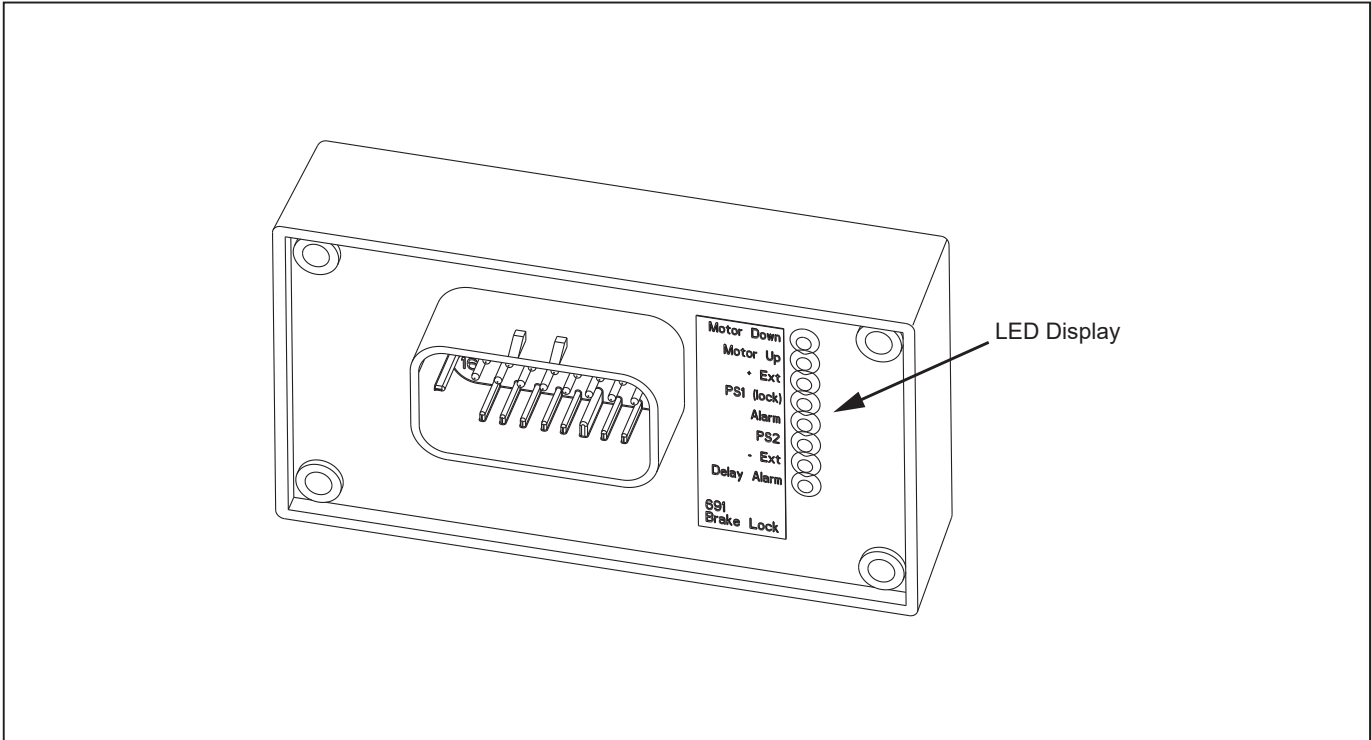

LED Display Explanation

Motor Down	On when system is releasing pressure. (Remains on for three seconds after PS2 goes off).
Motor up	On when system has been activated (proper signal on +Ext or -Ext, until PS1 comes on).
+ Ext	On when positive signal is present on brown harness wire and/or green user interface wire.
PS1 (lock)	On when system is locked at full pressure. Receives ground signal from pressure switch #1 on white wire.
Alarm	On when power unit is pressurizing the system. Controls user interface audible alarm.
PS2	On whenever any pressure is present in the system. Receives ground signal from pressure switch #2 on violet wire.
- Ext	On when negative signal is present on gray harness wire.
Delay Alarm (horn output)	Comes on 9 seconds after activating the system if full system pressure has not been attained. Also comes on anytime the power unit runs to repressurize the system.

The input LED's should be on when receiving their respective signal and off when not. Replace the 691 Control Module when this is not observed.

Situation	Cause/Solution (Test in order indicated)
<p>When the 691 System is activated, the brakes will not lock-up and the power unit does not run.</p>	<p>1. No electric power. <i>Check the battery, fuse, and wiring connections.</i></p>
	<p>2. High Pressure Switch is inoperative. <i>Activate the 691 System. If "PS1 (lock)" LED is on, unplug pressure switch 1. If pump runs, replace pressure switch 1 (high pressure switch) or check for a short to ground in the wiring.</i></p>
	<p>3. The Power Unit or Control Module is inoperative. <i>Activate the 691 System. If "Motor Up" LED is on, check for 12 Vdc at the power unit connector. Unplug the power unit and attach a voltmeter (+ to blue, - to green) to the connector leading to the control module. If 12 Vdc is present, replace the power unit. If 12 Vdc is not present, replace the control module.</i></p>
	<p>4. The Control Module is not receiving an input signal. <i>Activate the 691 System. Check "+ Ext" and "- Ext" LED's. If neither are on, check that a ground signal is present at the gray lead in the main wiring harness, or the green lead from the user interface; or that a positive signal is present on the brown wire in the main wiring harness. If not, determine the reason and correct.</i></p>
<p>When the 691 System is activated, the brakes will not lock-up and the power unit continues to run.</p>	<p>1. The fluid level in the reservoir is low. <i>Deactivate the 691 System. Verify that the power unit is mounted level. Remove the reservoir breather/filler plug and fill the reservoir with proper fluid to within 1/4 inch of top. Reinstall breather/filler plug.</i></p>
	<p>2. Hydraulic leak in either the 691 System or service brake system. <i>Inspect all tubing and connections for leaks and tighten or replace as necessary.</i></p>
	<p>3. The actuator is not functioning properly. <i>Activate the 691 System. Check the vehicle master cylinder reservoir for excessive fluid level. This condition indicates that the seals in the actuator are allowing 691 System fluid to leak into the vehicle service brake system. Refer to TABLE 1 (pages 19 and 20) for the proper actuator repair kit. Replace the seals in the actuator. NOTE: The vehicle brake system may need to be flushed and refilled.</i></p>
	<p>4. The power unit is not properly building pressure. <i>Replace the power unit. (no test to troubleshoot this condition).</i></p>
<p>The 691 System will activate and lock-up the brakes but the power unit keeps running.</p>	<p>1. High pressure switch is inoperative. <i>Active the 691 System . If "PS2" LED is off, replace pressure switch #1 (high pressure switch).</i></p>
<p>The power unit does not operate to release the brakes when the 691 System is deactivated.</p>	<p>1. No electric power. <i>Check the battery, fuse, and wiring connections.</i></p>
	<p>2. Low pressure switch is inoperative. <i>Deactivate the 691 system. If "PS2" LED is off, replace pressure switch #2 (low pressure switch).</i></p>
	<p>3. The power unit or control module is inoperative. <i>Deactivate the 691 System. If the "Motor Down" LED is on, check for 12 Vdc at power unit connector. Unplug power unit and attach a voltmeter (- to blue, + to green) to the connector leading to control module. If 12 Vdc is present, replace the power unit. If 12 Vdc is not present, replace control module.</i></p>
<p>The brakes release but the 691 Power Unit does not stop running.</p>	<p>1. Low pressure switch is inoperative. <i>Deactivate the 691 System. If the "PS2" LED is on, replace pressure switch #2 (low pressure switch).</i></p>
	<p>2. The control module is inoperative. <i>Deactivate the 691 System. If "Motor Down" LED is off, replace the control module.</i></p>

<p>The 691 System and “Motor Up” LED come on unexpectedly without being activated.</p>	<p>1. The control module is receiving false signals. <i>Be sure stray signals are not being introduced into the external inputs. If the gray wire is not connected to an external input, ensure that it is capped off and not shorting to ground inadvertently. NOTE: While deactivated, occasional operation of power unit and “Motor Down” LED is normal to relieve pressure caused by thermal expansion of fluid in the power unit.</i></p>
<p>While the 691 System is activated, the power unit and horn activate intermittently.</p>	<p>1. Change in temperature has caused the system to contract and reduce brake system pressure. <i>The power unit runs briefly to restore brake system pressure to the original lock-up pressure. This is considered normal operation as fluid temperature changes.</i></p>
	<p>2. The service brake system or 691 System has air in it. <i>Bleed service brakes and 691 System.</i></p>
	<p>3. Hydraulic leak in either the 691 System or service brake system. <i>Inspect all tubing and connectors for leaks and tighten or replace as necessary.</i></p>
	<p>4. The power unit is not functioning properly. <i>Replace the power unit. (No test to troubleshoot this condition).</i></p>

NOTES

691 MODELS AND REPLACEMENT PARTS**TABLE 1**

System Model Number	Description	691 Fluid	Vehicle Fluid	Power Unit	#1 - High Pressure Switch Kit	#2 - Low Pressure Switch Kit	
02-691-101	Single (1 3/4*)	SF	SF or BF	20-410-014	02-600-051	02-600-050	
02-691-109	Single (1 1/4*)	SF	SF or BF	20-410-014	02-600-051	02-600-050	
02-691-201	Dual (1 3/4*)	SF	SF or BF	20-410-014	02-600-051	02-600-050	
02-691-209	Dual (1 1/4*)	SF	SF or BF	20-410-014	02-600-051	02-600-050	
** 02-691-223	Dual (1 1/4*)	SF	SF or BF	20-410-014	02-600-051	02-600-050	
*** 02-691-303	3-Channel	SF	SF or BF	20-410-014	02-600-051	02-600-050	
**** 02-691-305	3-Channel	SF	SF or BF	20-410-014	02-600-051	02-600-050	
***** 02-691-403	4-Channel	SF	SF or BF	20-410-014	02-600-051	02-600-050	

BF = Brake Fluid SF = Silicone Fluid

* Inch diameter of actuator bore.

** Consists of two 1 1/4 inch diameter single actuator.

*** Consists of one 1 3/4 inch diameter single actuator and one 1 1/4 inch diameter dual actuator.

**** Consists of one 1 1/4 inch diameter single actuator and one 1 1/4 inch diameter dual actuator.

***** Consists of two 1 1/4 inch diameter dual actuators.

691 ACCESSORIES

Part Number	Description
02-600-038	Remote Reservoir Kit
02-600-049	Integral Reservoir Kit
32-820-022	11 foot long Extension Harness from Power Unit to Control Module

	User Interface	Control Module	Actuator	Actuator Repair Kit	Main Harness	Reservoir Breather Plug
	32-585-007	29-585-001	20-460-013	02-600-035	32-820-021	34-001-089
	32-585-007	29-585-001	20-460-018	02-600-042	32-820-021	34-001-089
	32-585-007	29-585-001	20-460-012	02-600-034	32-820-021	34-001-089
	32-585-007	29-585-001	20-460-017	02-600-041	32-820-021	34-001-089
	32-585-007	29-585-001	20-460-018 (two)	02-600-042 (two)	32-820-021	34-001-089
	32-585-007	29-585-001	20-460-013 (one) 20-460-017 (one)	02-600-035 02-600-041	32-820-021	34-001-089
	32-585-007	29-585-001	20-460-018 (one) 20-460-017 (one)	02-600-042 02-600-041	32-820-021	34-001-089
	32-585-007	29-585-001	20-460-017 (two)	02-600-041 (two)	32-820-021	34-001-089

NOTES

NOTES
